

Catalogue

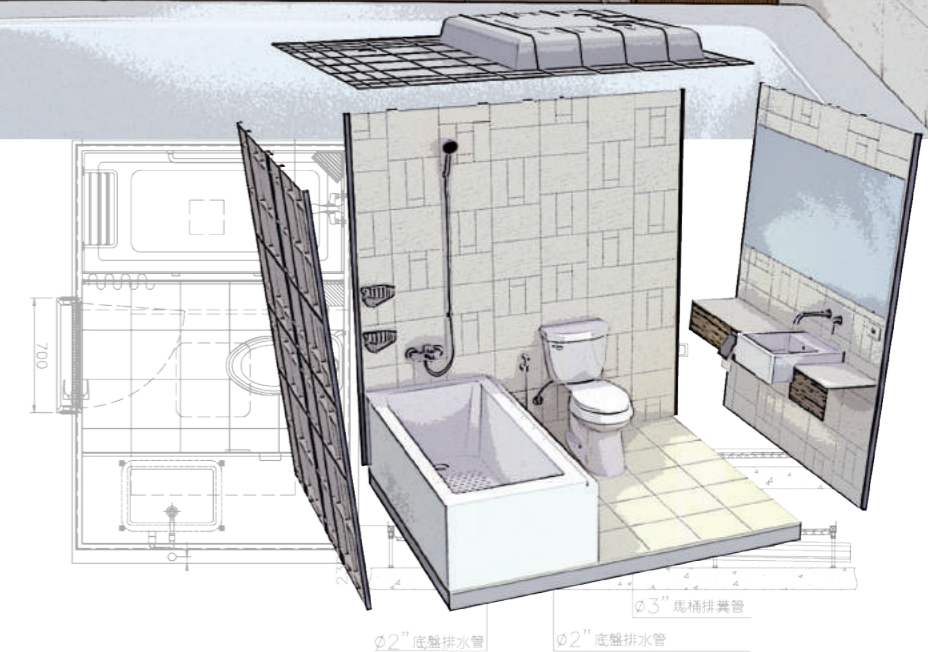

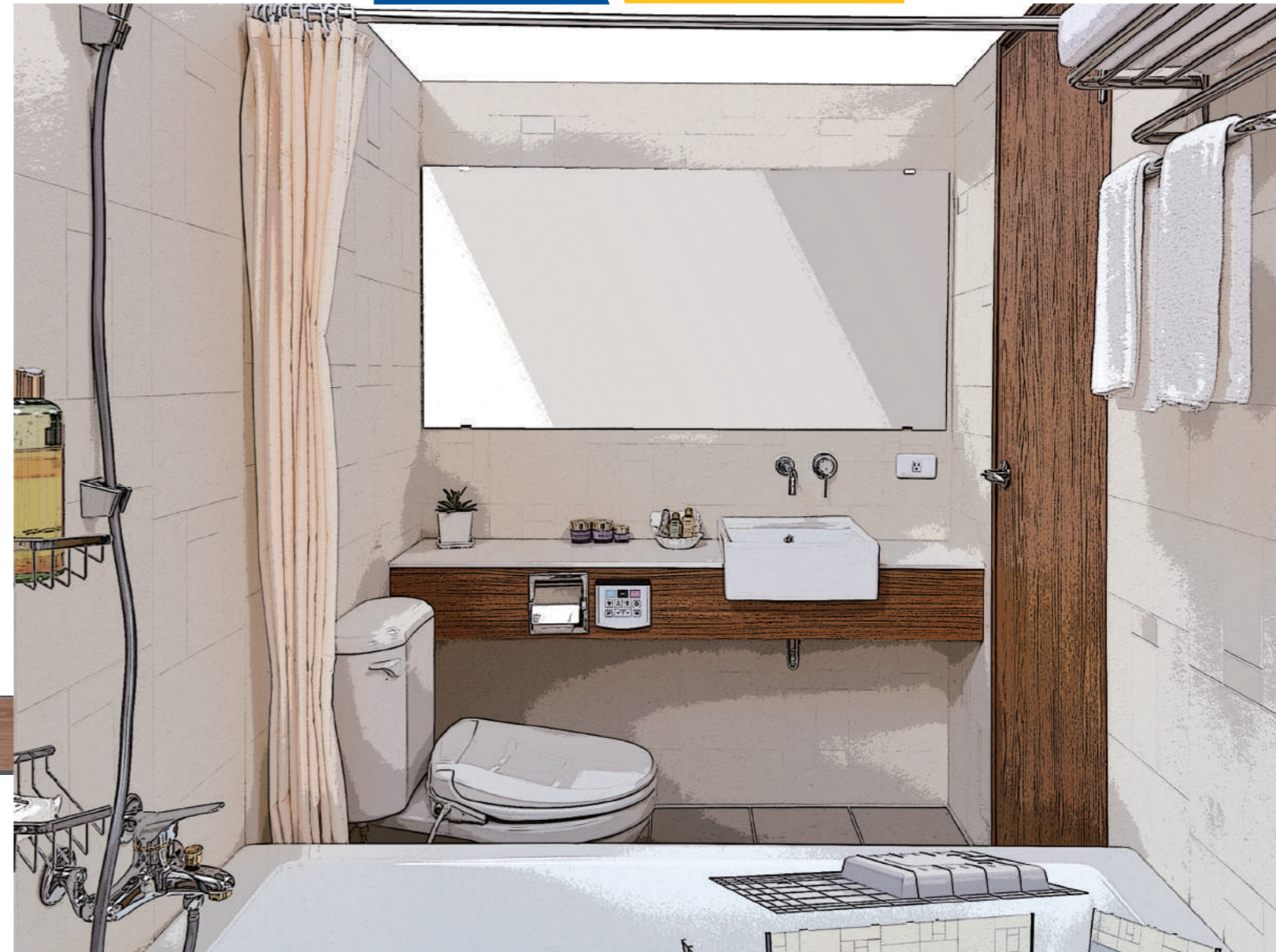

Catalogue

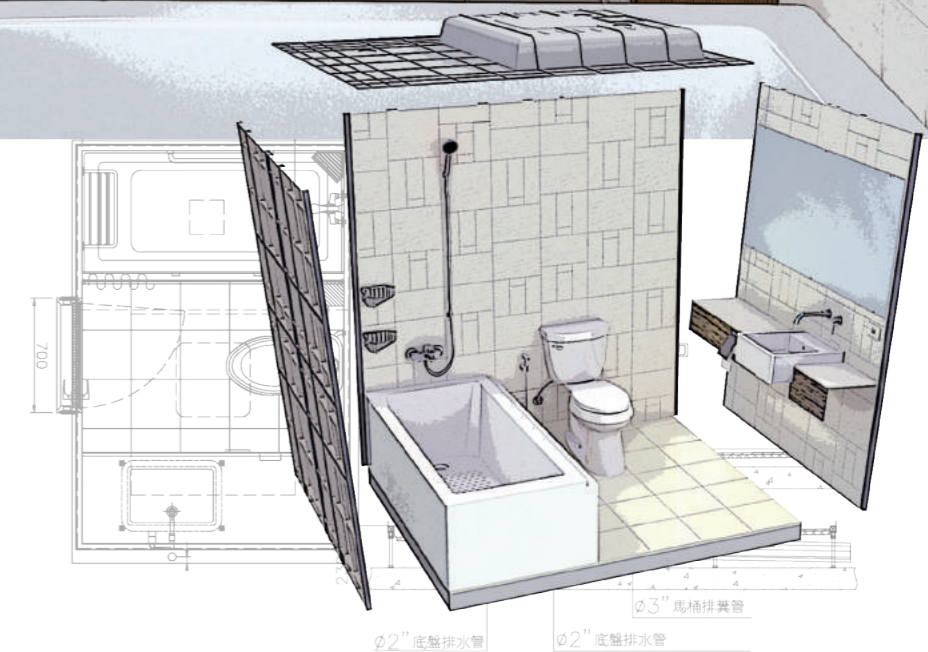



INDEX

LIST.....	3
PUDA PODS	5
FEATURE	7
MODELS	9
FUNCTION	35
ACCESSORIES	39
FINISH	41
INTERFACE	42

BATHROOM LIST

DOOR SIDE (DRAINAGE)	SHORT (RIGHT)	SHORT (LEFT)	LONG (RIGHT)	LONG (LEFT)	MIDDLE (RIGHT)	MIDDLE (LEFT)
MODEL/PAGE						
1624 A P. 9						
CODE	1624AAAR	1624AAAL	1624AABR	1624AABL	1624AACR	1624AACL
1624 B P. 11						
CODE					1624BACR	1624BACL
1620 B P. 13						
CODE					1620BACR	1620BACL
1616 A P. 15						
CODE	1616AAAR	1616AAAL	1616AABR	1616AABL		
1521 A P. 17						
CODE	1521AAAR	1521AAAL	1521AABR	1521AABL		
1521 D P. 19						
CODE	1521DAAR	1521DAAL	1521DABR	1521DABL		
1420 A P. 21						
CODE	1420AAAR	1420AAAL	1420AABR	1420AABL		
1418 A P. 23						
CODE	1418AAAR	1418AAAL	1418AABR	1418AABL		
1221D P. 25						
CODE	1221DAAR	1221DAAL	1221DABR	1221DABL		

BATHROOM LIST

DOOR SIDE (DRAINAGE)	SHORT (RIGHT)	SHORT (LEFT)	LONG (RIGHT)	LONG (LEFT)	MIDDLE (RIGHT)	MIDDLE (LEFT)
MODEL/PAGE						
1218 A P. 23						
CODE	1218AAAR	1218AAAL	1218AABR	1218AABL		
1216 A P. 27						
CODE	1216AAAR	1216AAAL	1216AABR	1216AABL		
1214 A P. 29						
CODE	1214AAAR	1214AAAL	1214AABR	1214AABL		
1214 C P. 31						
CODE	1214CAAR	1214CAAL	1214CABR	1214CABL		
1214 E P. 33						
CODE	1214EAAR	1214EAAL	1214EABR	1214EABL		
1014 A P. 29						
CODE	1014AAAR	1014AAAL	1014AABR	1014AABL		
1014 C P. 31						
CODE	1014CAAR	1014CAAL	1014CABR	1014CABL		
1014 E P. 33						
CODE	1014EAAR	1014EAAL	1014EABR	1014EABL		

PRODUCT CODE

EX:

1 0 1 4

SIZE

□

SERIES

□

A DIRECT DRAINAGE
B INDIRECT DRAINAGE

□

A DOOR OPEN (SHORT)
B DOOR OPEN (LONG)
C DOOR OPEN (MIDDLE)

A DRAINAGE DIRECTION (LEFT)
B DRAINAGE DIRECTION (RIGHT)

NOTE:

Above product code is for the type of direct drainage. Please select correct code when ordering.



PUDA GRP bathroom pod is composed of panelized floor base, wall panels and ceiling manufactured by high technic raw material and innovative manufacturing technology, with the integration of sanitary and MEP system. One unit of bathroom pod could be finished within **4 ~ 8** hours.

INSTALLATION



1. Floor base install

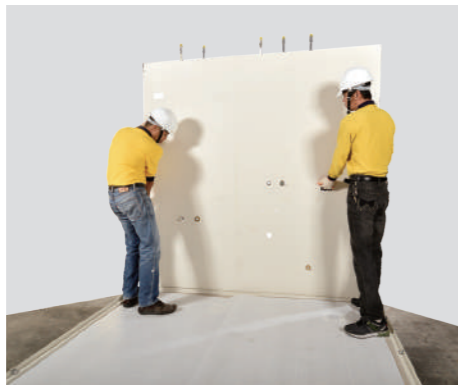

2. Wall panel install



3. Door install



4. Ceiling install



5. Fittings install



6. Completed Unit

BENIFIT

Fast Install, Single Source

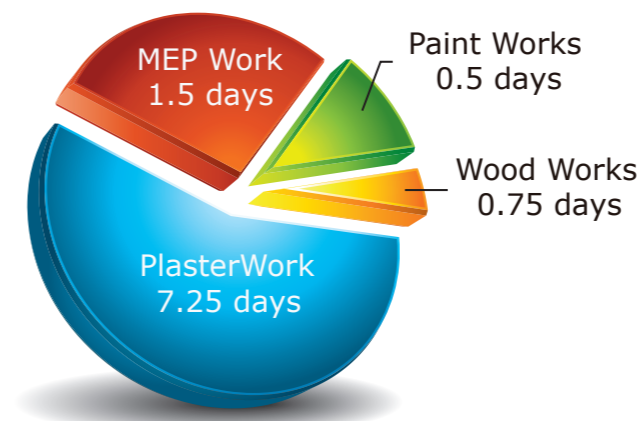

7.25 days for traditional bathroom work

Only 4 ~ 8 hours for PUDA bathroom pod

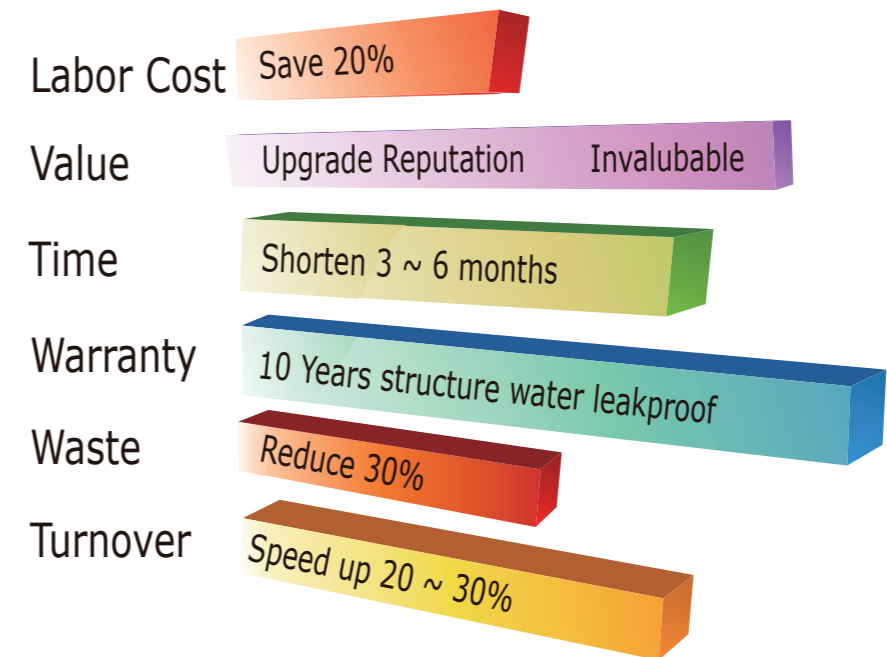

FEATURE

GRP WALL PANEL

TILED PATTERN

Tiled pattern embossment surface, Anti corrosion material, good durability.

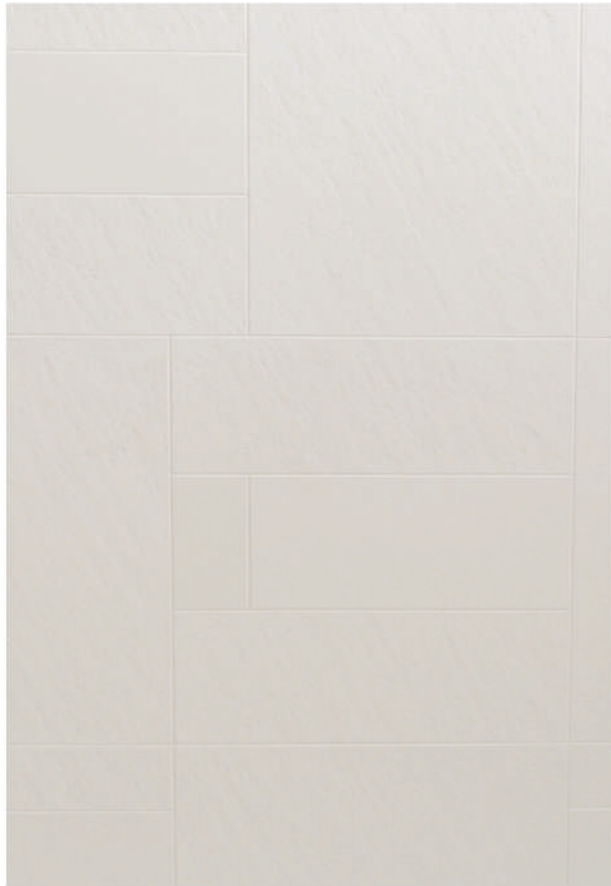

EASY CLEAN

Easy and simple clean design.

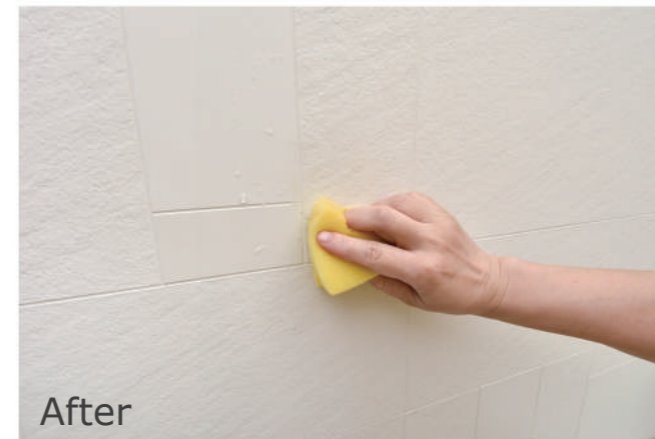
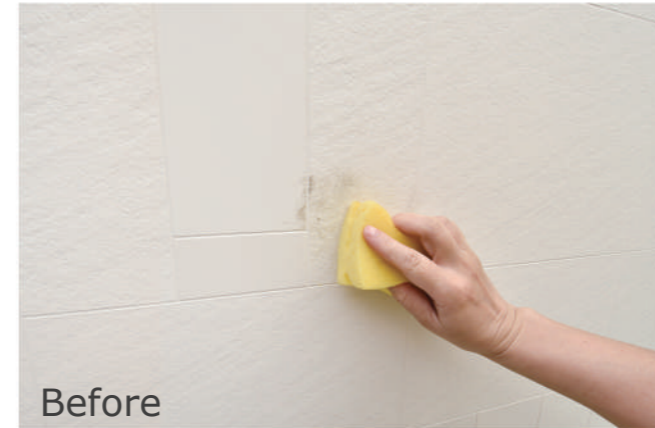

GFP CEILING

Same material as wall panel. One piece molded, dome shape. Maintenance Hatch.



TILED FLOOR

100% LEAKPROOF

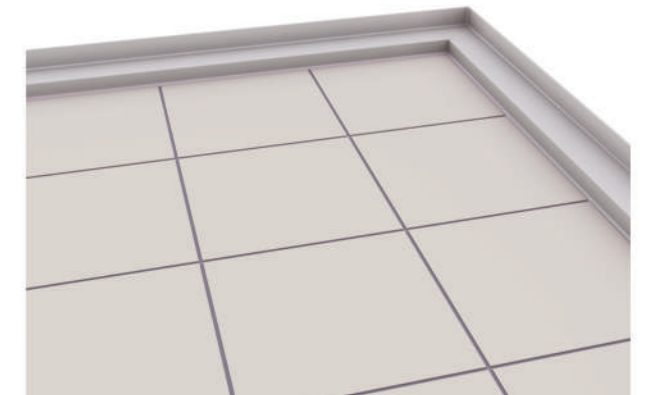
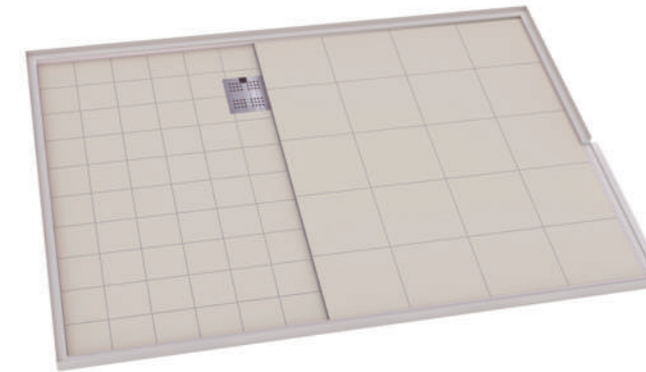

Water stop line design to guarantee 100% leakproof

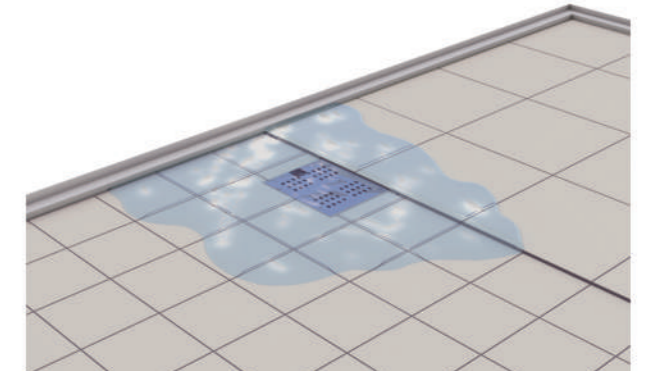

Draining slope design to meet 100% drainage



Polished tile surface, artistic and easy clean



Exclusive deodorant drain, easy clean



Lower threshold, safer and durable



Draining slope design in bath area, no obstruction

1624 A



SPECIFICATION

GROUP	PRODUCT	DESCRIPTION
STRUCTURE	CEILING	GRP (Hatch 450*450mm)
	WALL	GRP
	FLOOR	300*300mm polished tile
	DOOR	GRP
ACCESSORIES	TOILET	Flush: 6L
	COUNTER	Engineered stone Ceramic basin
	SCREEN	Tempered glass
	BASIN MIXER	Chrome, wall mounted
	SHOWER MIXER	Chrome
	MIRROR	W1480*H750mm
	EXTRACT FAN	110V-240V/60Hz
	DOWN LIGHT	LED 9W, 120-240V
	TOWEL RACK	Stainless steel
	SHELF	Stainless steel
	PAPER HOLDER	Chrome
HOOK	Chrome	
WEIGHT	512kg ± 3%	

DIMENSION

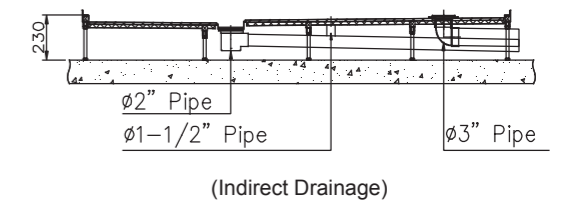
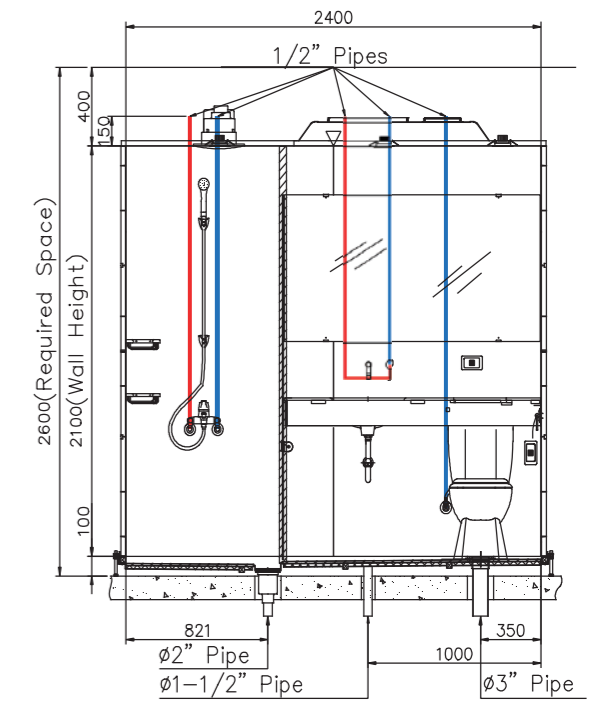
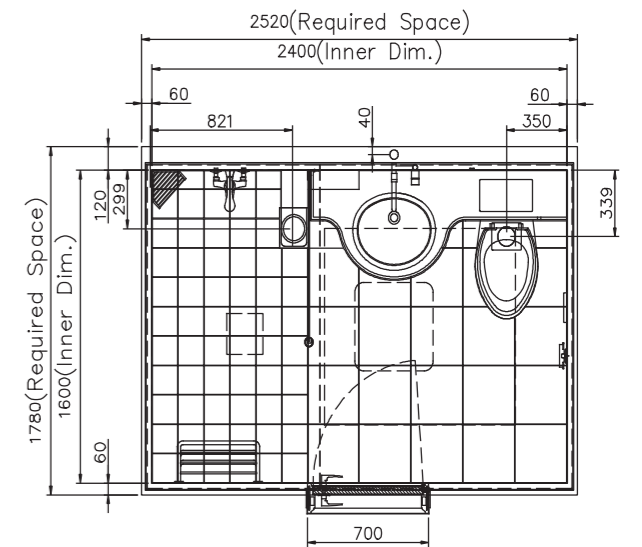

MODELS

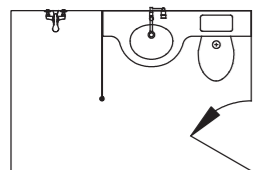

1624AAAR

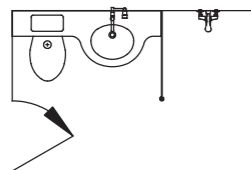

1624AAAL

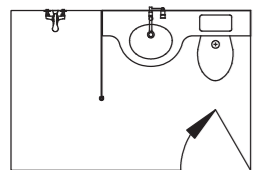

1624AABR

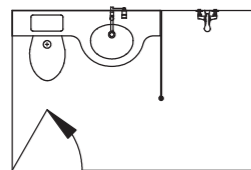

1624AABL

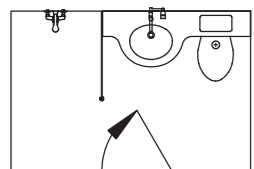

1624AACR

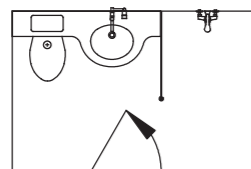

1624AACL



1624 B



SPECIFICATION

GROUP	PRODUCT	DESCRIPTION
STRUCTURE	CEILING	GRP (Hatch 450*450mm)
	WALL	GRP
	FLOOR	300*300mm polished tile
	DOOR	GRP
ACCESSORIES	TOILET	Flush: 6L
	COUNTER	Engineered stone Ceramic basin
	BATHTUB	Acrylic
	BASIN MIXER	Chrome, wall mounted
	SHOWER MIXER	Chrome
	MIRROR	W1580*H750mm
	EXTRACT FAN	110V-240V/60Hz
	DOWN LIGHT	LED 9W, 120-240V
	TOWEL RACK	Stainless steel
	SHELF	Stainless steel
	PAPER HOLDER	Chrome, recessed
	HOOK	Chrome
	GRAB BAR	L=600mm, stainless
CURTAIN	Chrome	
WEIGHT	470kg ± 3%	

DIMENSION

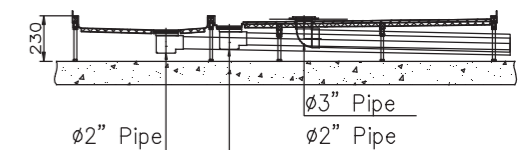
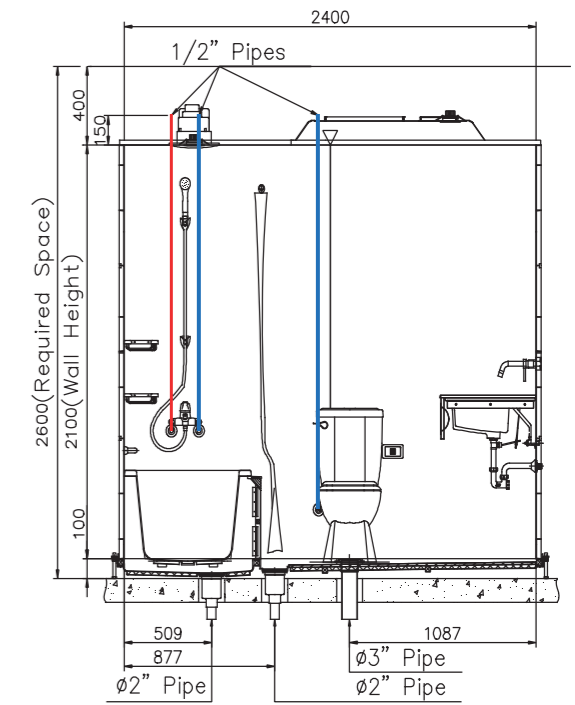
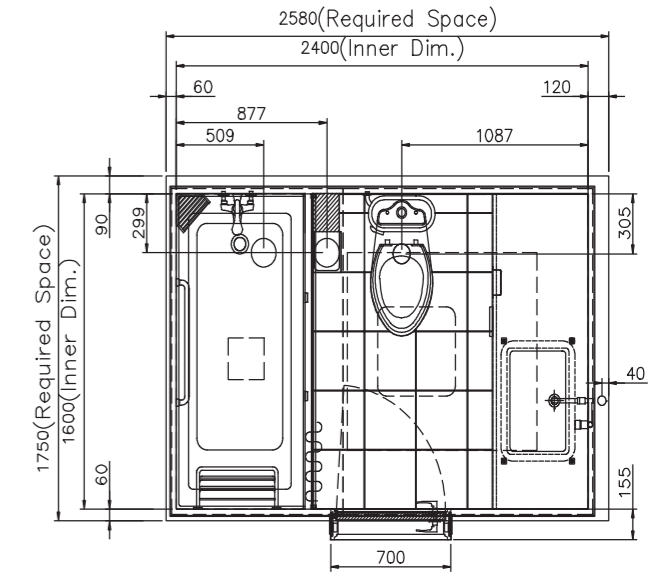

(Indirect Drainage)

MODELS

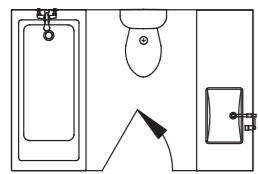

1624BACR

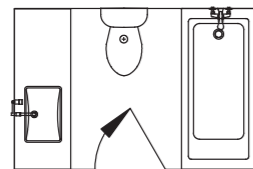

1624BACL



1620 B



SPECIFICATION

GROUP	PRODUCT	DESCRIPTION
STRUCTURE	CEILING	GRP (Hatch 450*450mm)
	WALL	GRP
	FLOOR	300*300mm polished tile
	DOOR	GRP
ACCESSORIES	TOILET	Flush: 6L
	COUNTER	Engineered stone Ceramic basin
	BATHTUB	Acrylic
	BASIN MIXER	Chrome, wall mounted
	SHOWER MIXER	Chrome
	MIRROR	W1580*H750mm
	EXTRACT FAN	110V-240V/60Hz
	DOWN LIGHT	LED 9W, 120-240V
	TOWEL RACK	Stainless steel
	SHELF	Stainless steel
	PAPER HOLDER	Chrome, recessed
	HOOK	Chrome
	GRAB BAR	L=600mm, stainless
	CURTAIN	Al. rope with PVC curtain
WEIGHT	440kg ± 3%	

DIMENSION

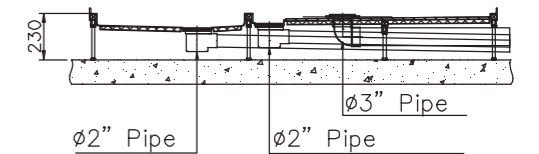
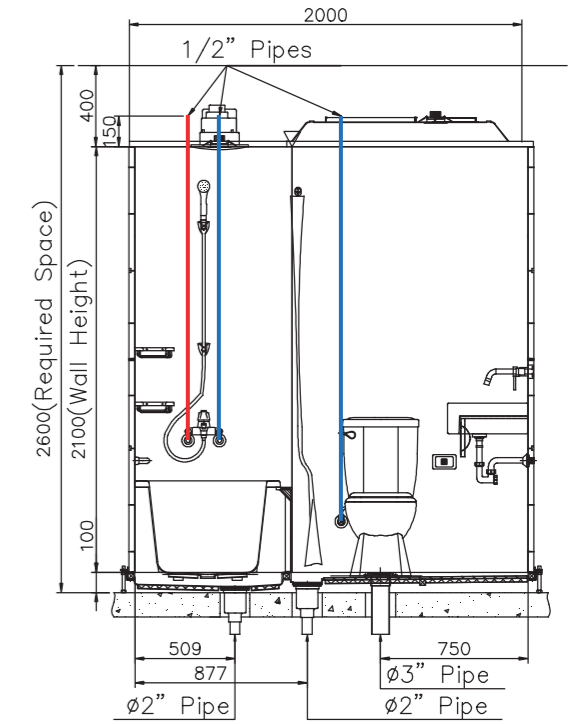
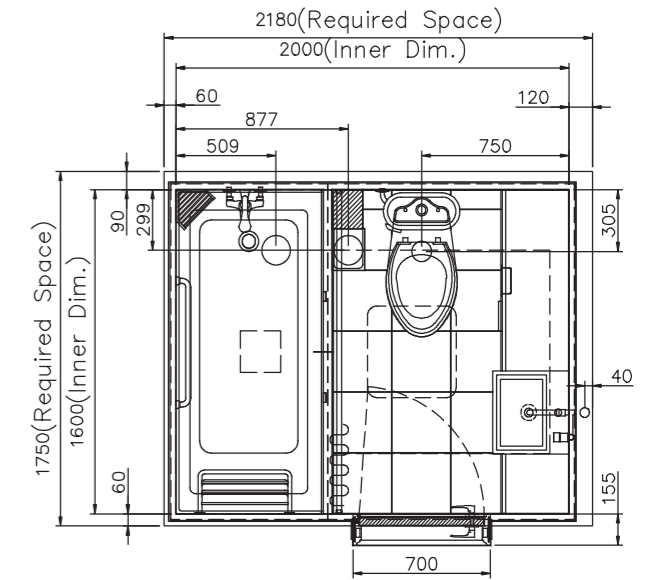

(Indirect Drainage)

MODELS

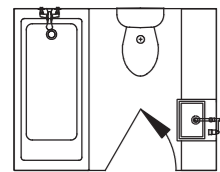

1620BACR

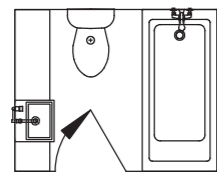

1620BACL



1616 A



SPECIFICATION

GROUP	PRODUCT	DESCRIPTION
STRUCTURE	CEILING	GRP (Hatch 450*450mm)
	WALL	GRP
	FLOOR	300*300mm polished tile
	DOOR	GRP
ACCESSORIES	TOILET	Flush: 6L
	VANITY CABINET	Recessed ceramic basin MFC wooden cabinet
	SHOWER DOOR	Al. fame with tempered glass
	BIDET SPRAYER	Chrome plastic
	BASIN MIXER	Chrome, wall mounted
	SHOWER MIXER	Chrome
	MIRROR	W600*H800mm
	EXTRACT FAN	110V-240V/60Hz
	DOWN LIGHT	LED 9W, 120-240V
	TOWEL RACK	Stainless steel
	SHELF	Plastic
	PAPER HOLDER	Chrome
	HOOK	Chrome
GLASS SHELF	Tempered glass	
WEIGHT	394kg ± 3%	

DIMENSION

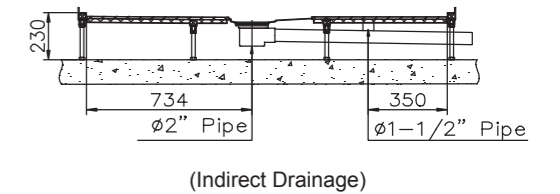
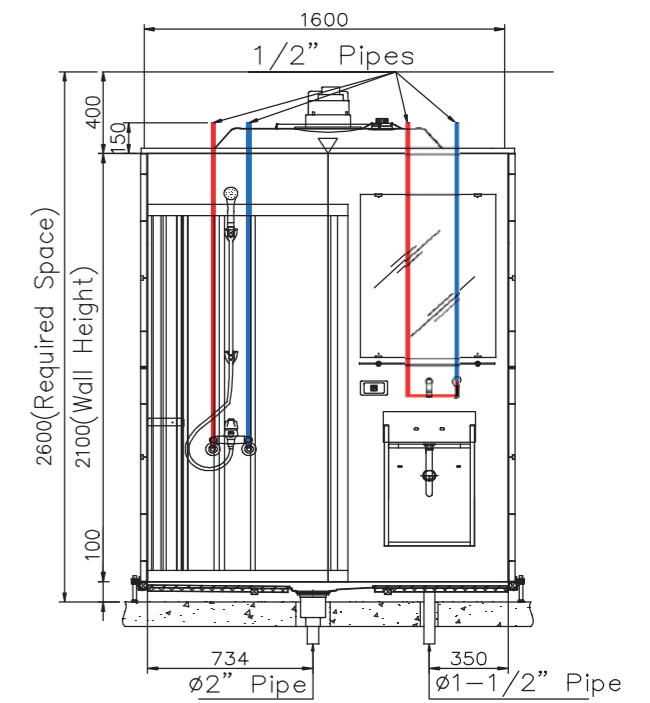
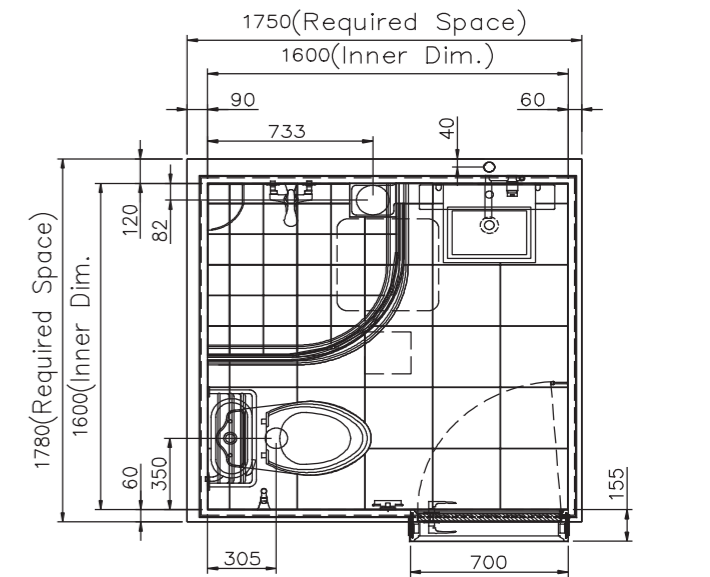

MODELS

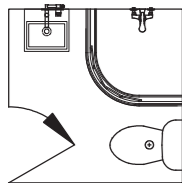

1616AAAR

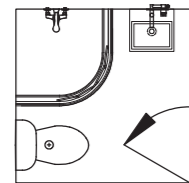

1616AAAL

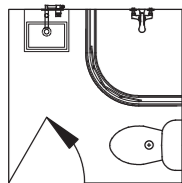

1616AABR

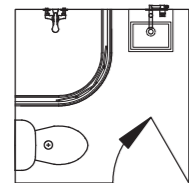

1616AABL



1521 A



SPECIFICATION

GROUP	PRODUCT	DESCRIPTION
STRUCTURE	CEILING	GRP (Hatch 450*450mm)
	WALL	GRP
	FLOOR	300*300mm polished tile
	DOOR	GRP
ACCESSORIES	TOILET	Flush: 6L
	VANITY CABINET	Recessed ceramic basin MFC wooden cabinet
	SCREEN	Tempered glass
	BIDET SPRAYER	Chrome plastic
	BASIN MIXER	Chrome, wall mounted
	SHOWER MIXER	Chrome
	MIRROR	W600*H800mm
	EXTRACT FAN	110V-240V/60Hz
	DOWN LIGHT	LED 9W, 120-240V
	TOWEL RACK	Stainless steel
	SHELF	Plastic
	PAPER HOLDER	Chrome
	HOOK	Chrome
GLASS SHELF	Tempered glass	
WEIGHT	466kg ± 3%	

DIMENSION

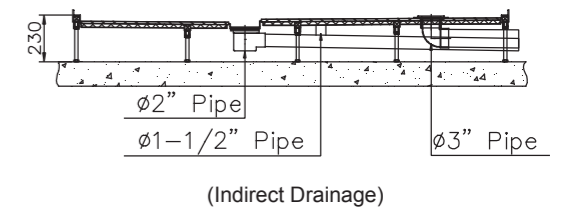
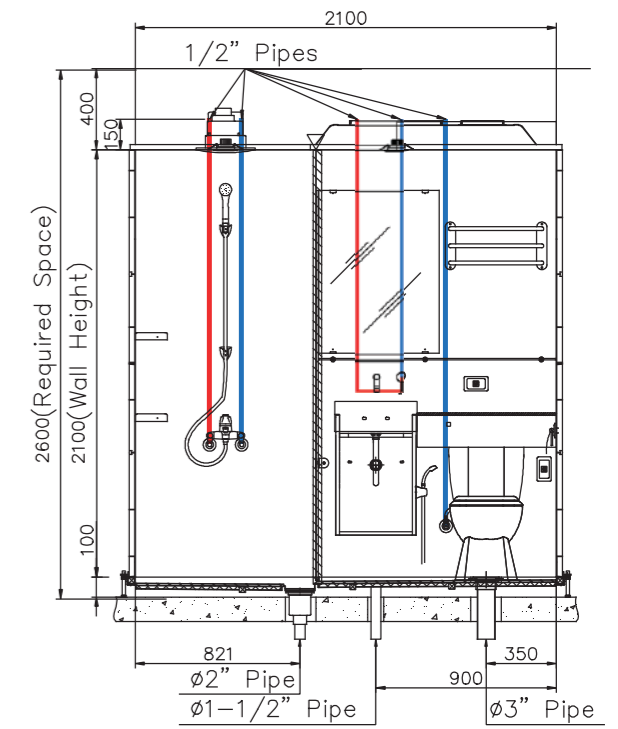
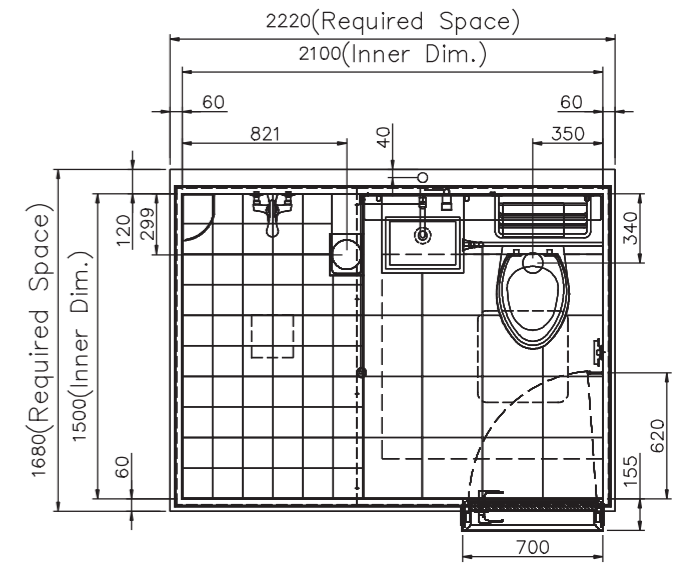

MODELS

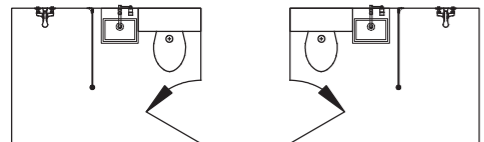

1521AAAR

1521AAAL

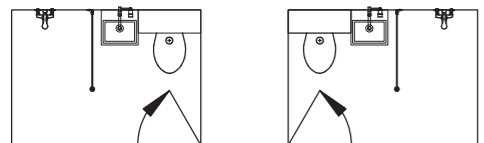

1521AABR

1521AABL



1521 D



SPECIFICATION

GROUP	PRODUCT	DESCRIPTION
STRUCTURE	CEILING	GRP (Hatch 450*450mm)
	WALL	GRP
	FLOOR	300*300mm polished tile
	DOOR	GRP
ACCESSORIES	TOILET	Flush: 6L
	VANITY CABINET	Recessed ceramic basin MFC wooden cabinet
	SCREEN	Tempered glass
	BIDET SPRAYER	Chrome plastic
	BASIN MIXER	Chrome, wall mounted
	SHOWER MIXER	Chrome
	MIRROR	W600*H800mm
	EXTRACT FAN	110V-240V/60Hz
	DOWN LIGHT	LED 9W, 120-240V
	TOWEL RACK	Stainless steel
	SHELF	Plastic
	PAPER HOLDER	Chrome
HOOK	Chrome	
GLASS SHELF	Tempered glass	
WEIGHT	446kg ± 3%	

DIMENSION

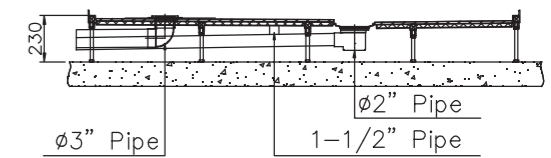
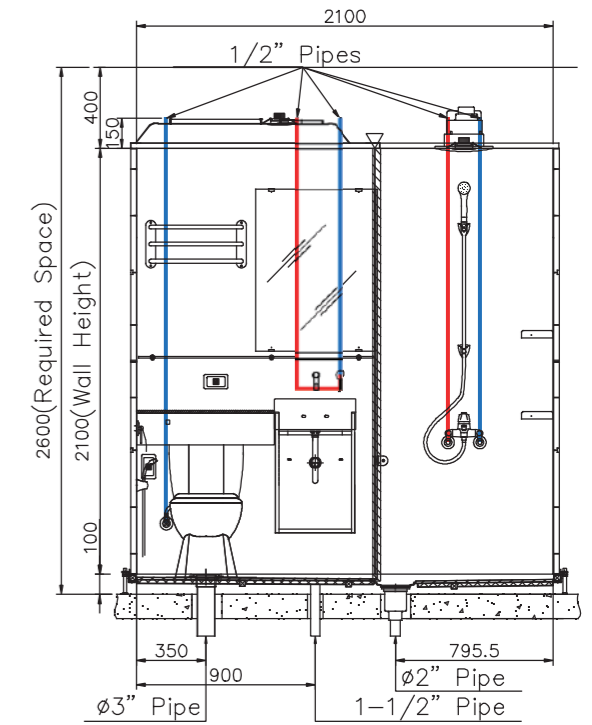
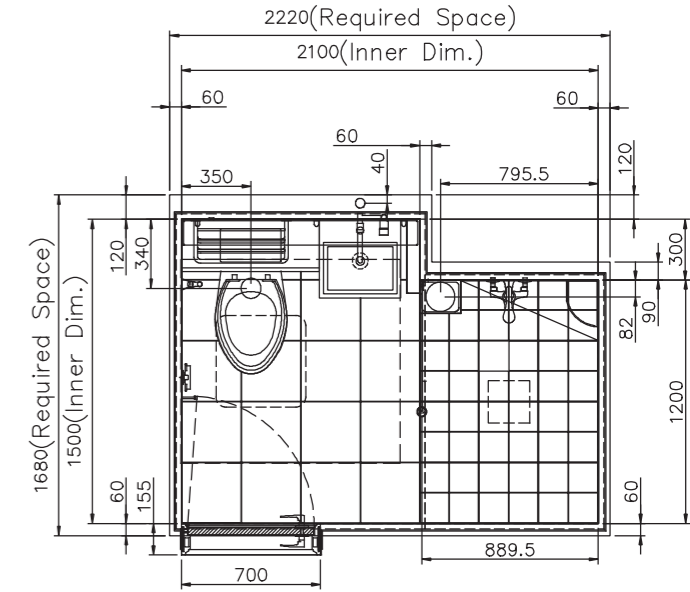

(Indirect Drainage)

MODELS

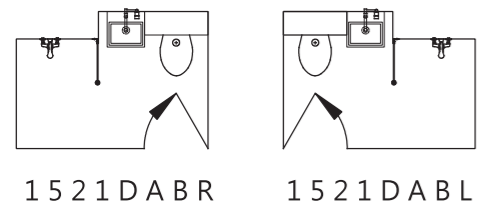
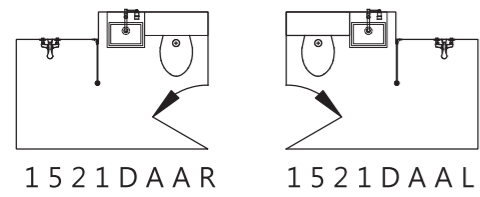

1420 A



SPECIFICATION

GROUP	PRODUCT	DESCRIPTION
STRUCTURE	CEILING	GRP (Hatch 450*450mm)
	WALL	GRP
	FLOOR	300*300mm polished tile
	DOOR	GRP
ACCESSORIES	TOILET	Flush: 6L
	VANITY CABINET	Recessed ceramic basin MFC wooden cabinet
	BIDET SPRAYER	Chrome plastic
	BASIN MIXER	Chrome, wall mounted
	SHOWER MIXER	Chrome
	MIRROR	W600*H800mm
	EXTRACT FAN	110V-240V/60Hz
	DOWN LIGHT	LED 9W, 120-240V
	TOWEL RACK	Stainless steel
	SHELF	Plastic
	PAPER HOLDER	Chrome
	HOOK	Chrome
	GLASS SHELF	Tempered glass
CURTAIN	Al. rod with PVC curtain	
WEIGHT	406kg ± 3%	

DIMENSION

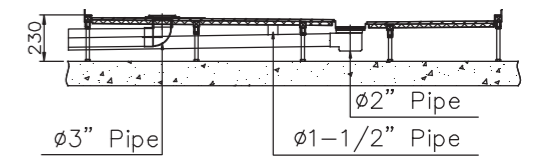
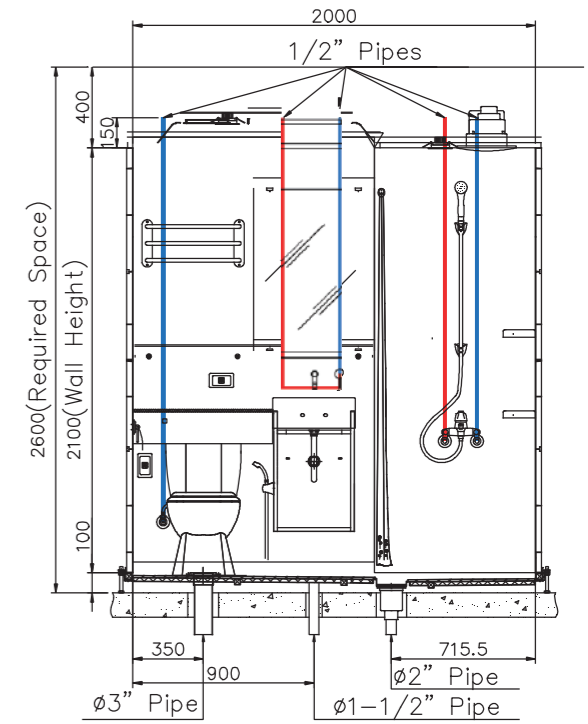
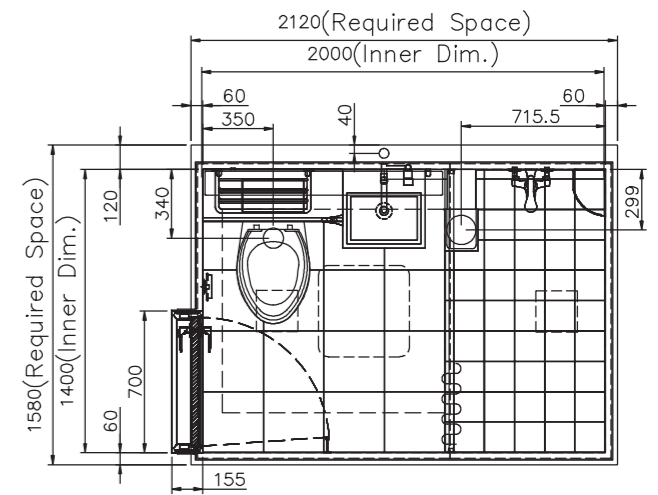

(Indirect Drainage)

MODELS

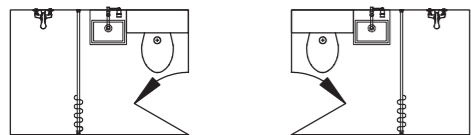

1420AAR

1420AAL

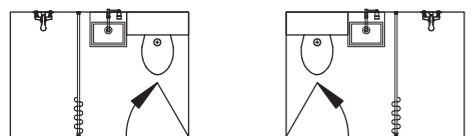

1420ABR

1420ABL



1418 A / 1218 A



MODELS

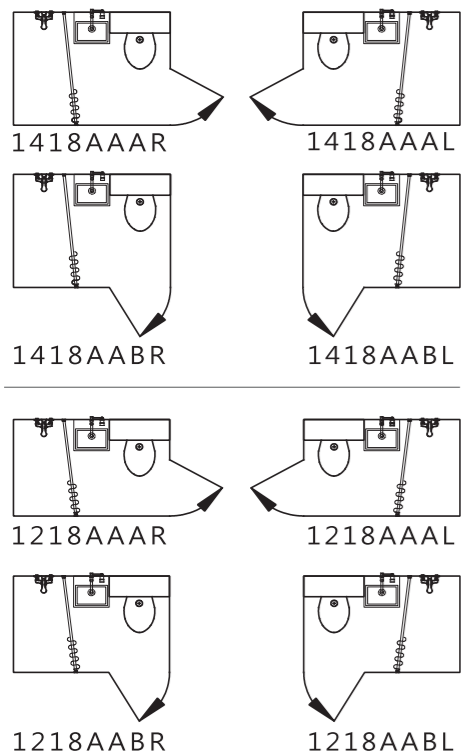

SPECIFICATION

GROUP	PRODUCT	1418 A	1218 A
STRUCTURE	CEILING	GRP (Hatch 450*450mm)	
	WALL	GRP	
	FLOOR	300*300mm polished tile	
	DOOR	GRP	
ACCESSORIES	TOILET	Flush: 6L	
	VANITY CABINET	Recessed ceramic basin MFC wooden cabinet	
	BIDET SPRAYER	Chrome plastic	
	BASIN MIXER	Chrome, wall mounted	
	SHOWER MIXER	Chrome	
	MIRROR	W600*H800mm	
	EXTRACT FAN	110V-240V/60Hz	
	DOWN LIGHT	LED 9W, 120-240V	
	TOWEL RACK	Stainless steel	
	SHELF	Plastic	
	PAPER HOLDER	Chrome	
	HOOK	Chrome	
	GLASS SHELF	Tempered glass	
CURTAIN	Al. rod with PVC curtain		
WEIGHT		365kg ± 3%	326kg ± 3%

DIMENSION

1418 A

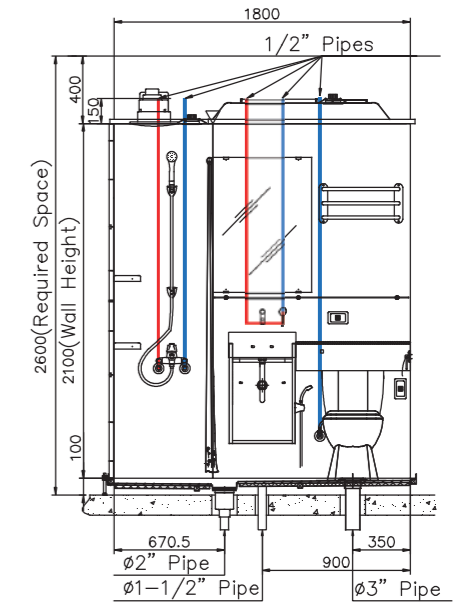
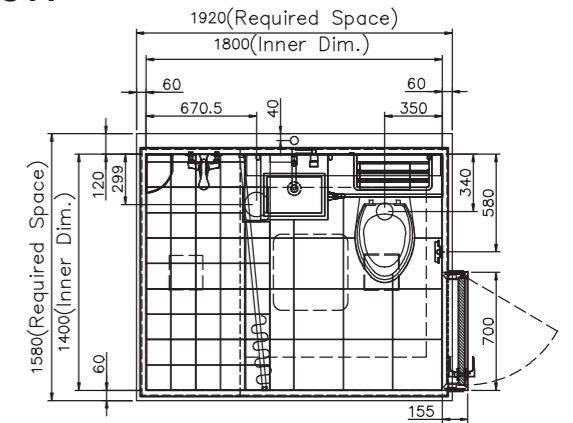

1218 A

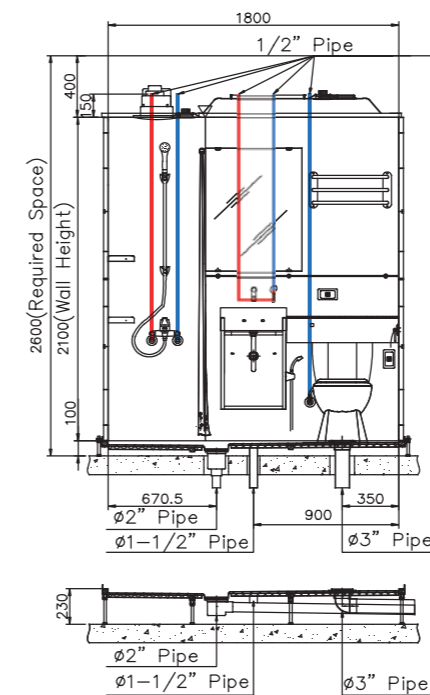
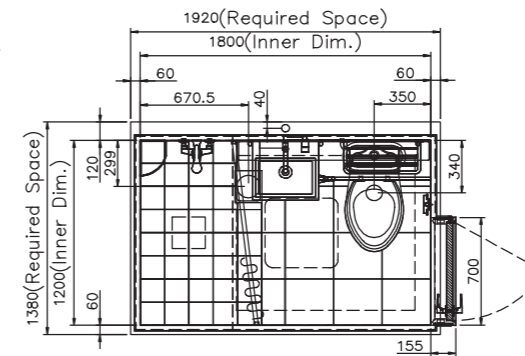

(Indirect Drainage)

(Indirect Drainage)

1221 D



SPECIFICATION

GROUP	PRODUCT	DESCRIPTION
STRUCTURE	CEILING	GRP (Hatch 450*450mm)
	WALL	GRP
	FLOOR	300*300mm polished tile
	DOOR	GRP
ACCESSORIES	TOILET	Flush: 6L
	VANITY CABINET	Recessed ceramic basin MFC wooden cabinet
	SCREEN	Tempered glass
	BIDET SPRAYER	Chrome plastic
	BASIN MIXER	Chrome, wall mounted
	SHOWER MIXER	Chrome
	MIRROR	W600*H800mm
	EXTRACT FAN	110V-240V/60Hz
	DOWN LIGHT	LED 9W, 120-240V
	TOWEL RACK	Stainless steel
	SHELF	Plastic
	PAPER HOLDER	Chrome
	HOOK	Chrome
GLASS SHELF	Tempered glass	
WEIGHT	411kg ± 3%	

DIMENSION

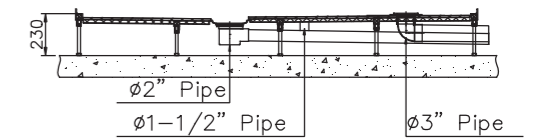
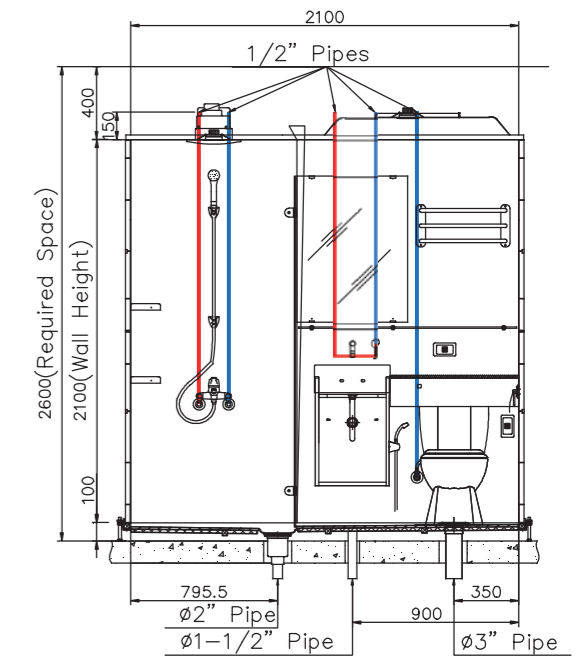
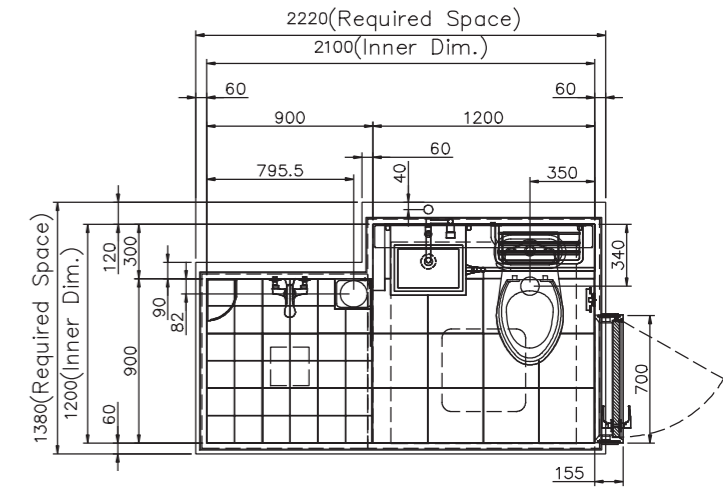

(Indirect Drainage)

MODELS

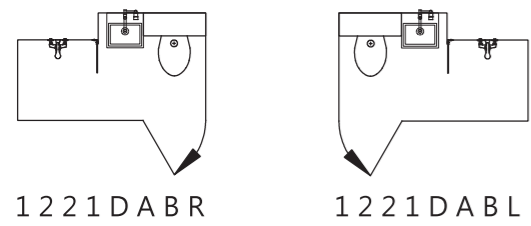
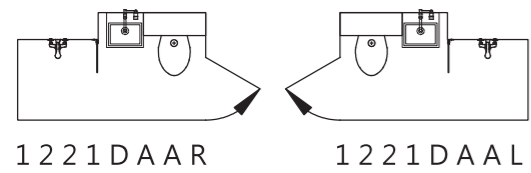

1216 A



SPECIFICATION

GROUP	PRODUCT	DESCRIPTION
STRUCTURE	CEILING	GRP (Hatch 450*450mm)
	WALL	GRP
	FLOOR	300*300mm polished tile
	DOOR	GRP
ACCESSORIES	TOILET	Flush: 6L
	VANITY CABINET	Recessed ceramic basin MFC wooden cabinet
	BIDET SPRAYER	Chrome plastic
	BASIN MIXER	Chrome, wall mounted
	SHOWER MIXER	Chrome
	MIRROR	W600*H800mm
	EXTRACT FAN	110V-240V/60Hz
	DOWN LIGHT	LED 9W, 120-240V
	TOWEL RACK	Stainless steel
	SHELF	Plastic
	PAPER HOLDER	Chrome
	HOOK	Chrome
	GLASS SHELF	Tempered glass
WEIGHT	307kg ± 3%	

DIMENSION

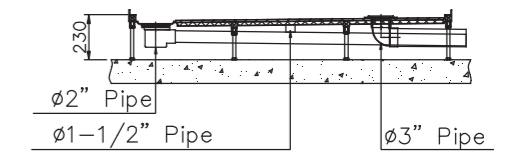
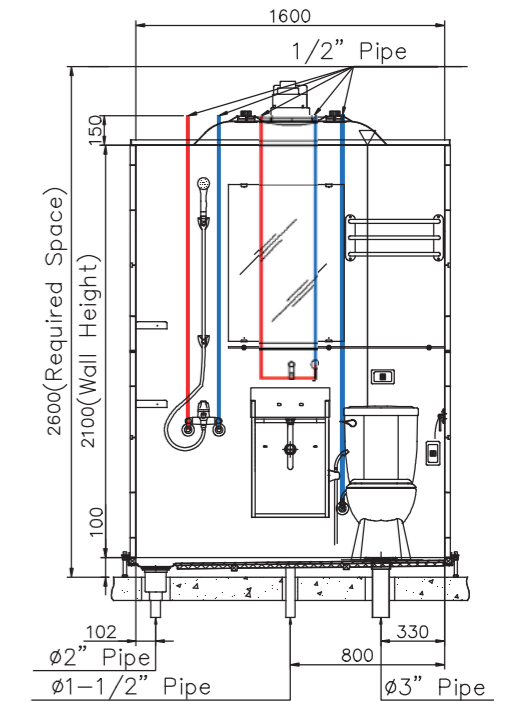
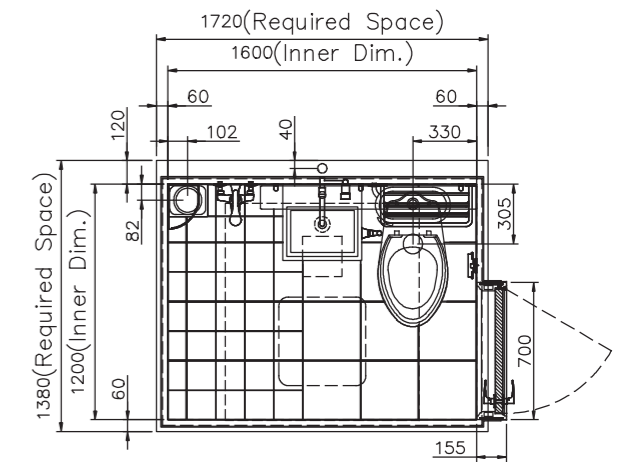

(Indirect Drainage)

MODELS

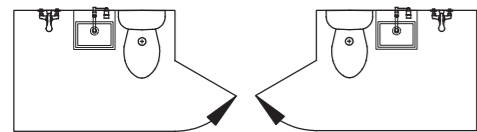

1216AAAR

1216AAAL

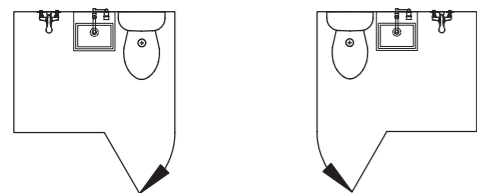

1216AABR

1216AABL



1014 A / 1214 A



SPECIFICATION

GROUP	PRODUCT	1014 A	1214 A
STRUCTURE	CEILING	GRP (Hatch 450*450mm)	
	WALL	GRP	
	FLOOR	200*200mm polished tile	
	DOOR	GRP	
ACCESSORIES	TOILET	Flush: 6L	
	BASIN	Ceramic, wall hang type	
	BIDET SPRAYER	Chrome plastic	
	BASIN MIXER	Chrome	
	MIRROR	W600*H800mm	
	EXTRACT FAN	110V-240V/60Hz	
	DOWN LIGHT	LED 9W, 120-240V	
	TOWEL BAR	Stainless, L=475mm	
	PAPER HOLDER	Chrome	
GLASS SHELF	Tempered glass		
WEIGHT		228kg ± 3%	250kg ± 3%

DIMENSION

1214 A

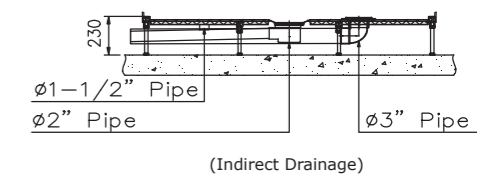
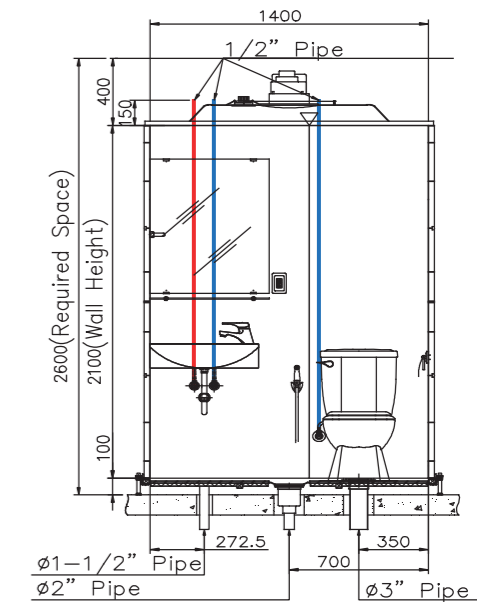
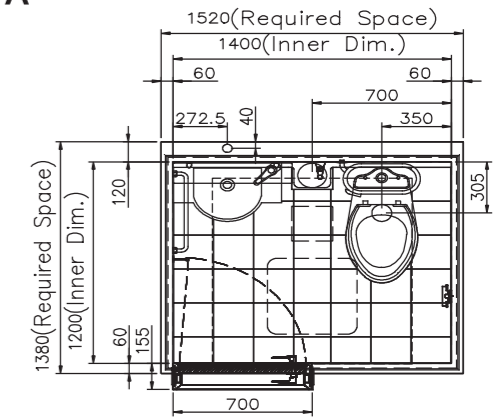

1014 A

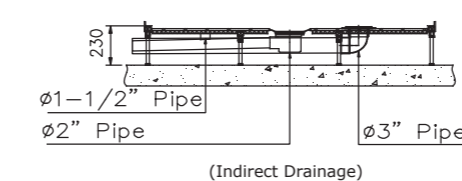
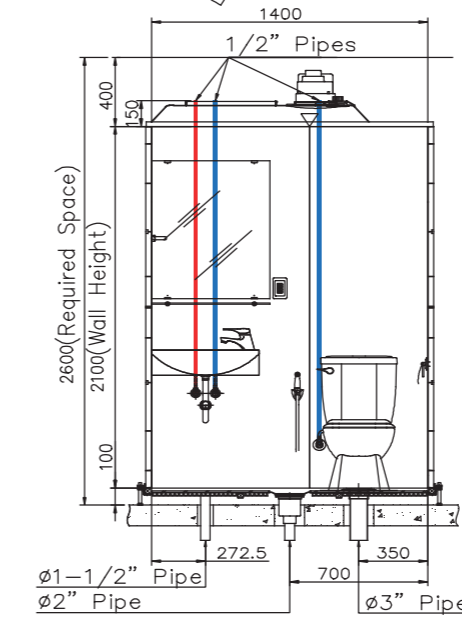
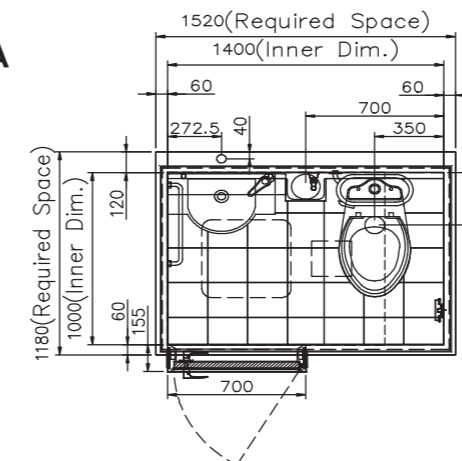

MODELS

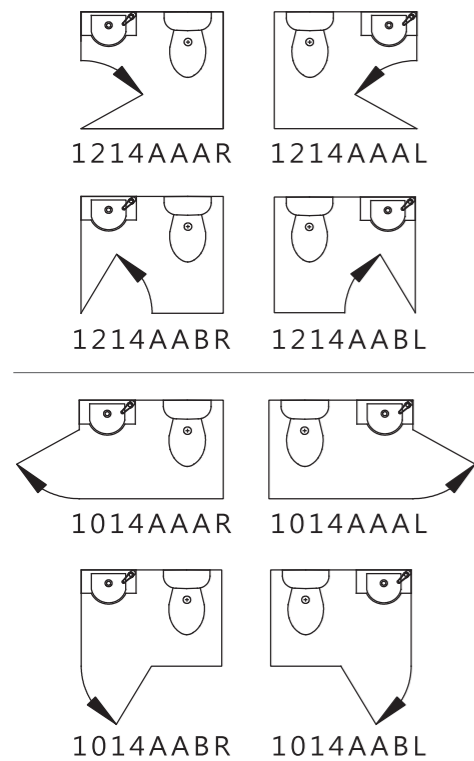

1014 C / 1214 C



SPECIFICATION

GROUP	PRODUCT	1014 C	1214 C
STRUCTURE	CEILING	GRP (Hatch 450*450mm)	
	WALL	GRP	
	FLOOR	200*200mm tile	
	DOOR	GRP	
ACCESSORIES	URIANL	Automatic, AC 110V	
	BASIN	Ceramic, wall hang type	
	BASIN MIXER	Chrome	
	MIRROR	W600*H800mm	
	EXTRACT FAN	110V-240V/60Hz	
	DOWN LIGHT	LED 9W, 120-240V	
	TOWEL BAR	Stainless, L=475mm	
	PAPER HOLDER	Chrome	
	GLASS SHELF	Tempered glass	
	WEIGHT	228kg ± 3%	238kg ± 3%

DIMENSION

1214 C

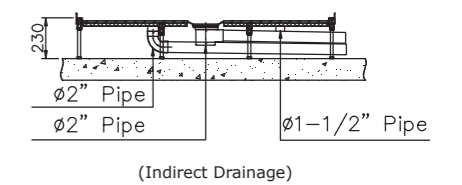
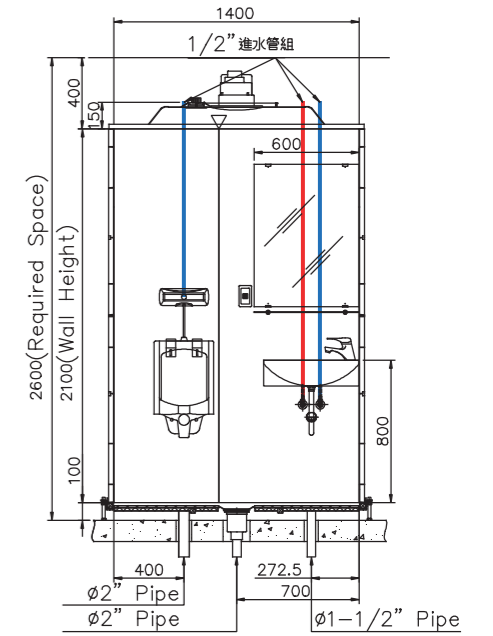
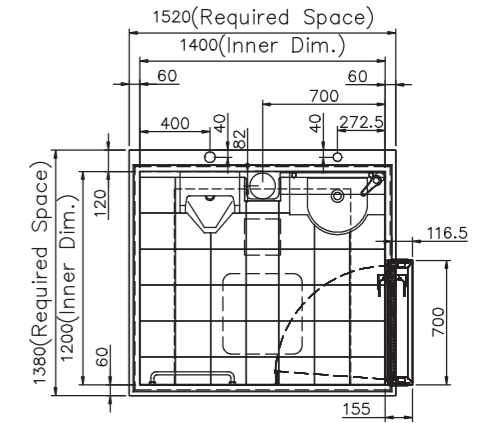

1014 C

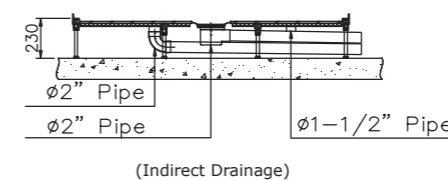
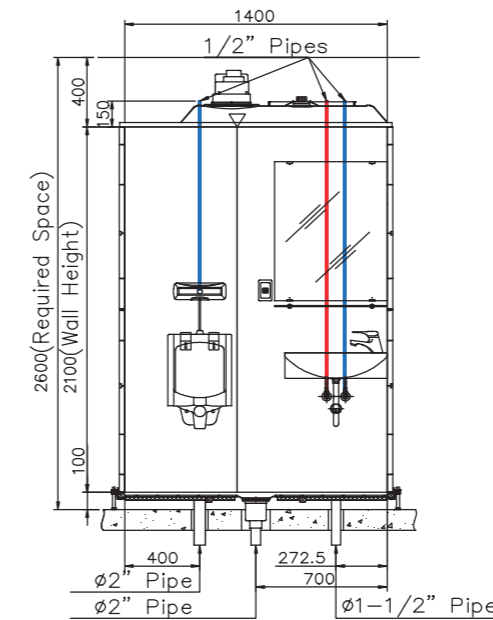
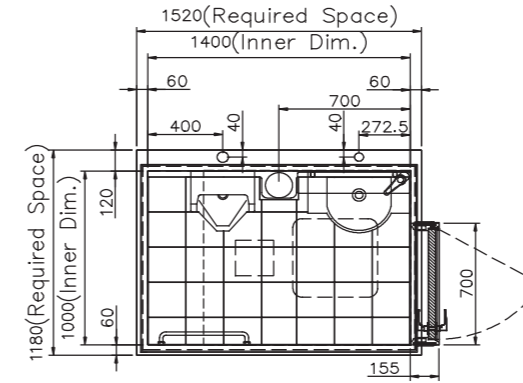

MODELS

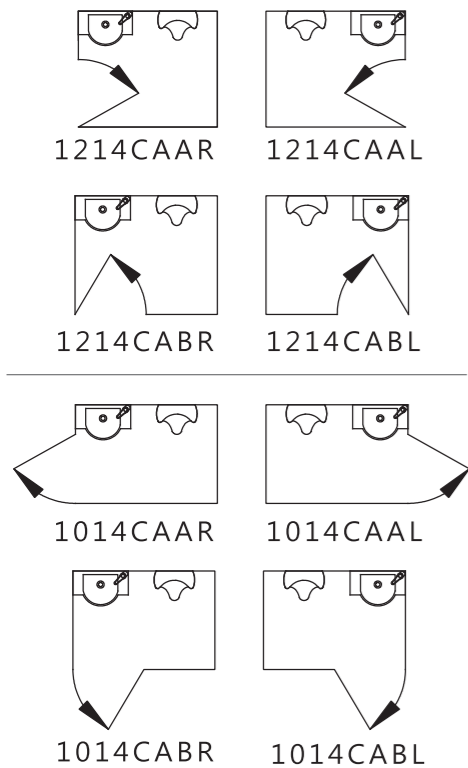

1014 E / 1214 E



SPECIFICATION

GROUP	PRODUCT	1014 E	1214 E
STRUCTURE	CEILING	GRP (Hatch 450*450mm)	
	WALL	GRP	
	FLOOR	200*200mm tile	
	DOOR	GRP	
ACCESSORIES	BASIN	Ceramic, wall hang type	
	BASIN MIXER	Chrome	
	SHOWER MIXER	Chrome	
	MIRROR	W600*H800mm	
	EXTRACT FAN	110V-240V/60Hz	
	DOWN LIGHT	LED 9W, 120-240V	
	TOWEL RACK	Stainless steel	
	SHELF	Plastic	
	PAPER HOLDER	Chrome	
	GLASS SHELF	Tempered glass	
WEIGHT		209kg ± 3%	297kg ± 3%

DIMENSION

1214 E

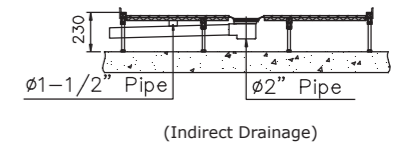
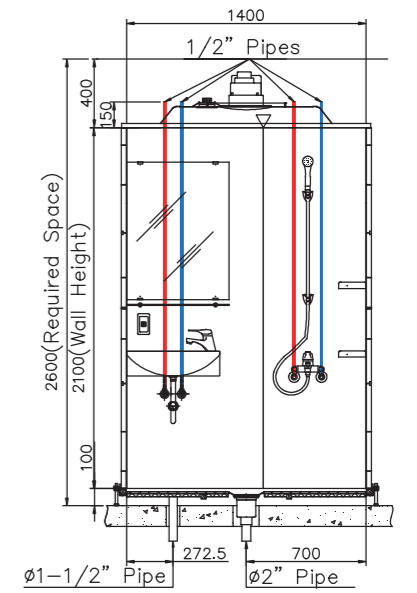
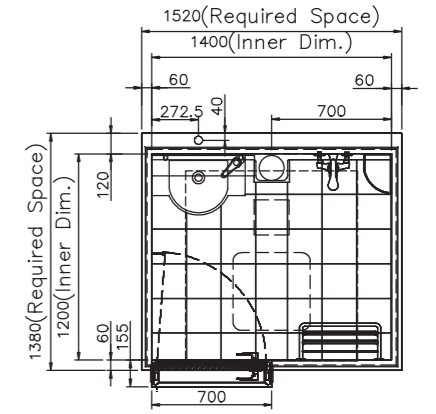

1014 E

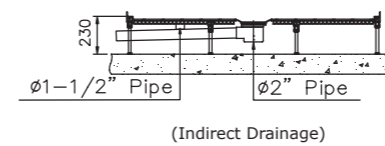
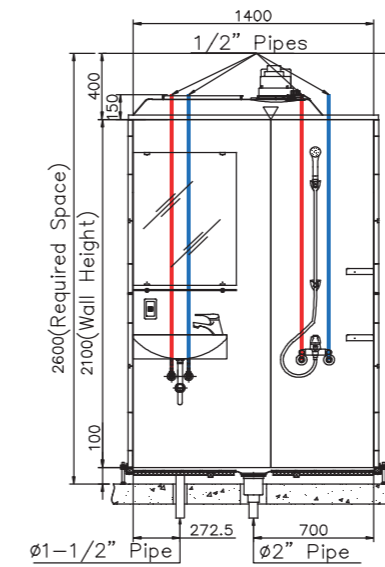
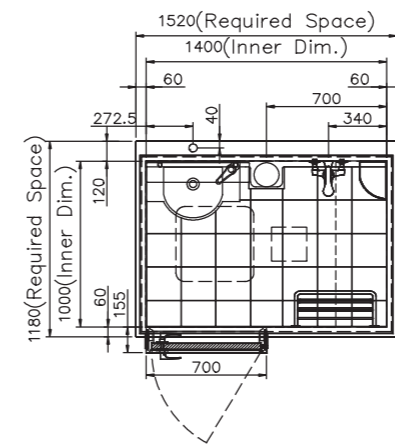

MODELS

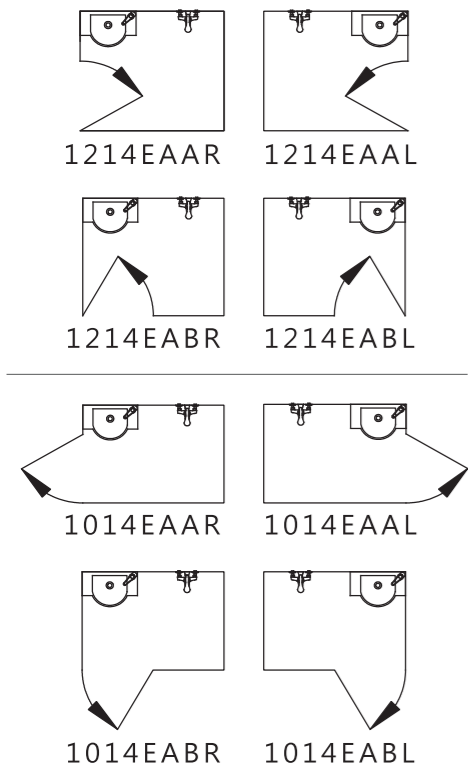

FUNCTION

DELICATE



Nature style design



Arch shape to create more space



Mounted basin mixer, more storage space



Reduce mold, easy clean



Small size tiles to create anti-slip function



Nature style door set, solid and durable



Unique mirror clips to provide safer installation, remove easily



STORAGE SPACE



Simple cabinet for more storage space



Removable counter hole for easier maintenance

DRY/WET SEPERATION



Shower screen for wet insulation



Diverse curtain location to create more shower space

FUNCTION

EASY CLEAN

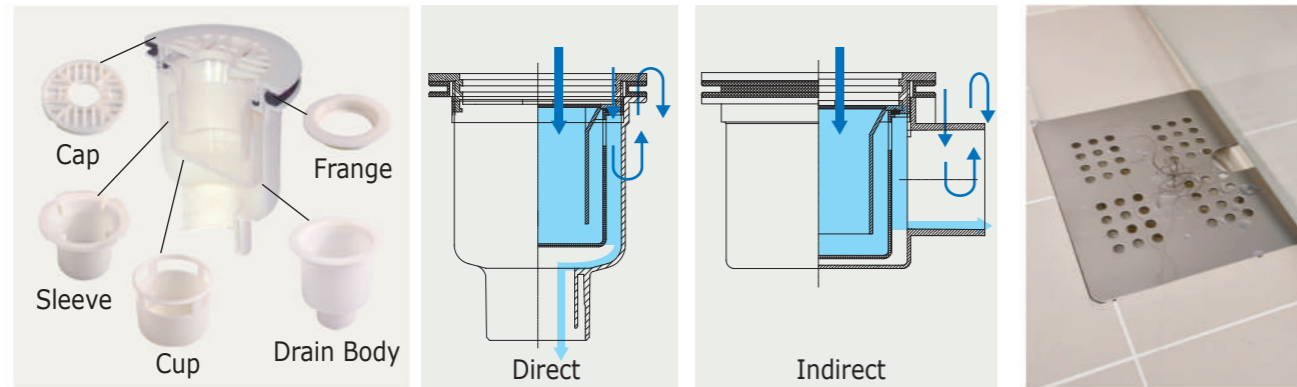

Removable design, easy clean Deodorant design

Drain cover to block hairs



Cleaning Steps



Removable side panel to have easier repair



Bidet sprayer for body cleanin or bathroom cleaning



SAVE ENERGY



Water efficient toilet, meet LEED standard, save engery

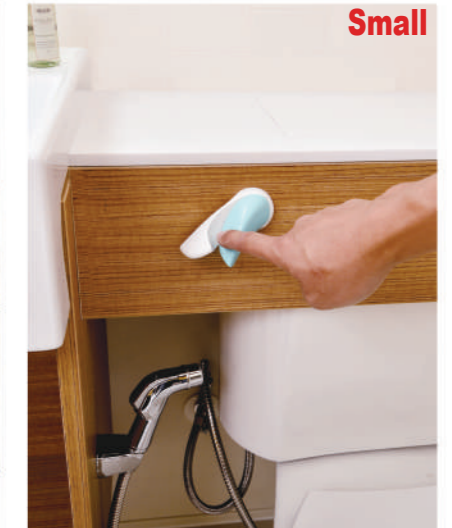

LED down light, durable, low energy, install simply



SMART



Smart washlet for better cleaning function



Remote controller easy operation

ACCESSORIES

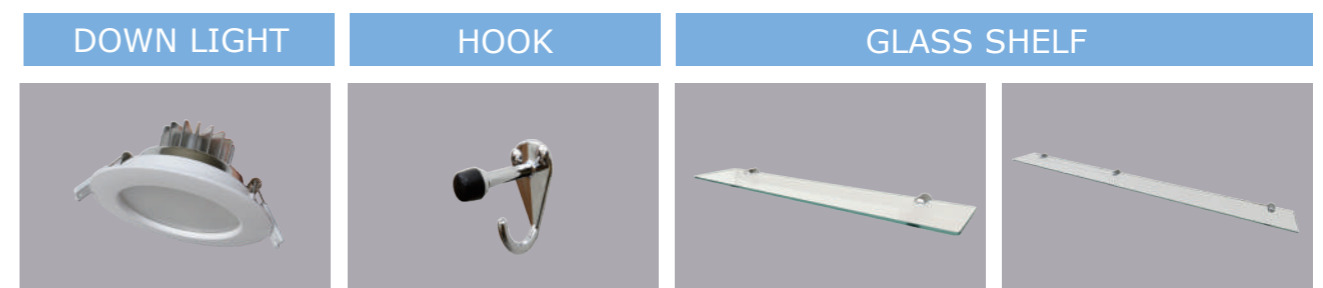
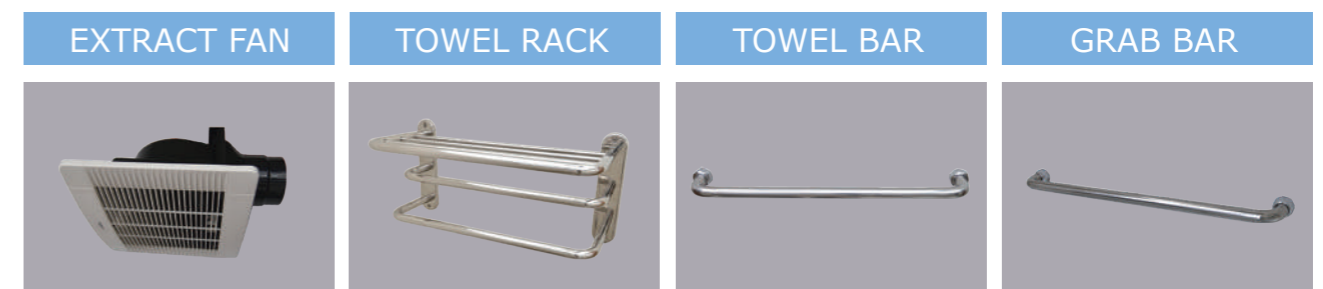
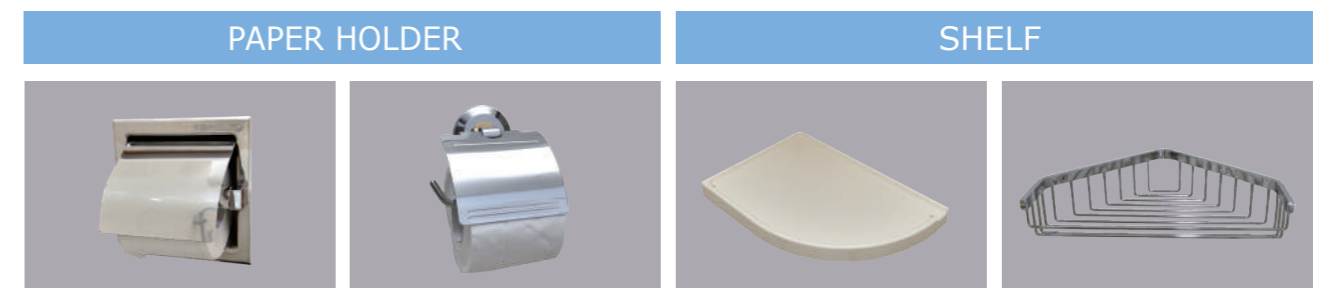
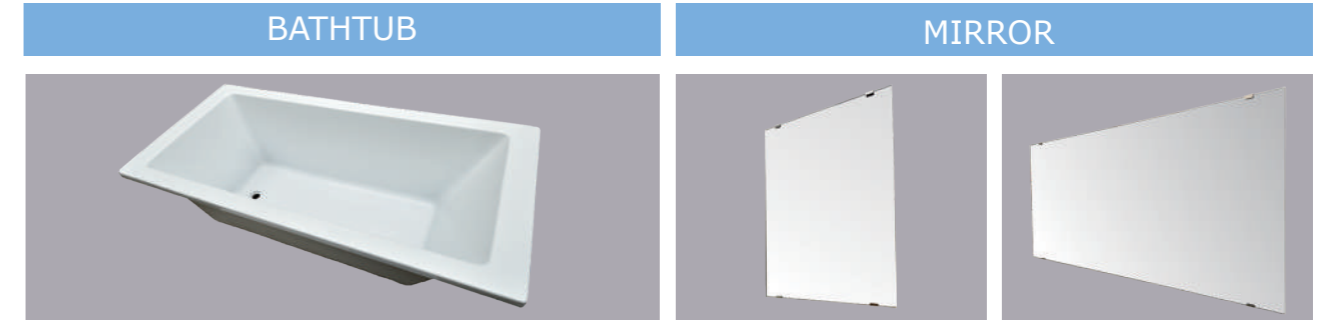

DOOR FINISH

TOP

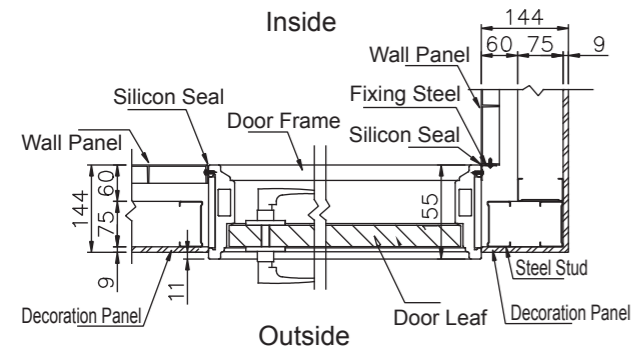

SECTION

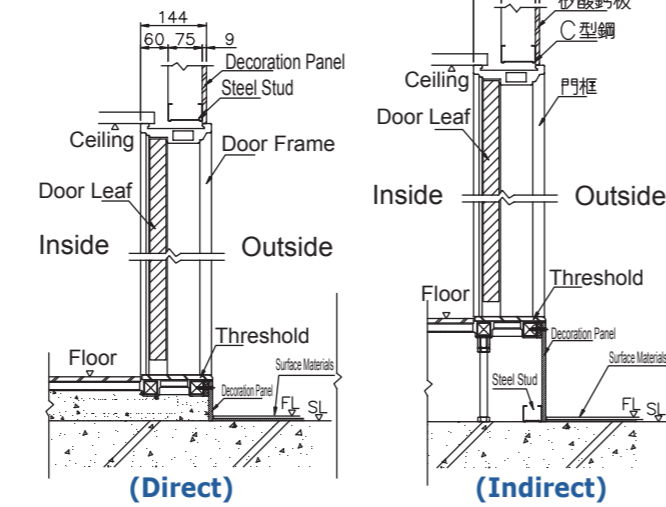

WINDOW FINISH

TOP

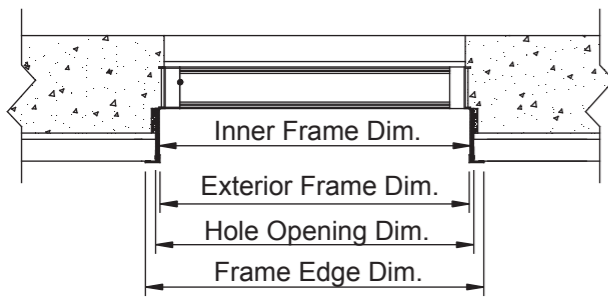

(Door frame material could be aluminum, wood, plastic, nature stone, engineered stone, stainless steel, etc.)

SECTION

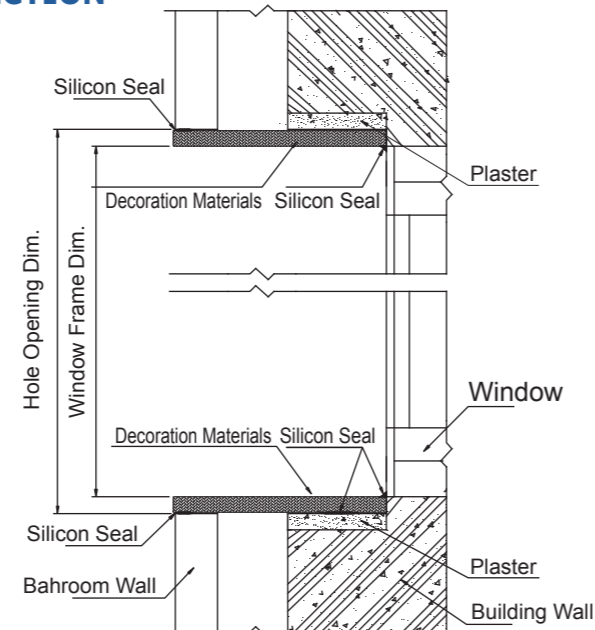

LIMITATION

Following building design is not suitable for using bathroom pod.

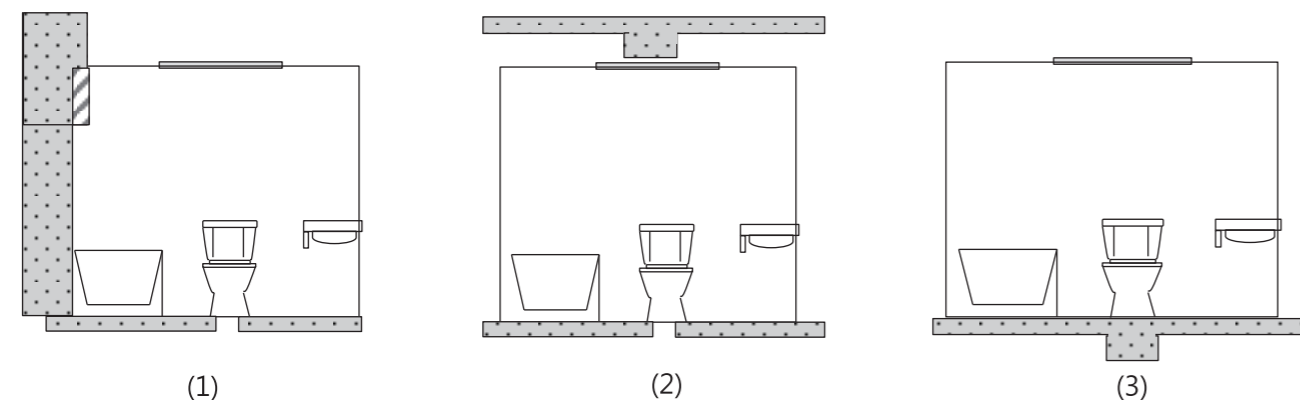

INTERFACE

A. Fresh Pipes Interface

100mm above ceiling ; 1/2 " pipe adapters.

B. Electricity Interface

Cables connect to ceiling junction box.

C. Extract Fan

Other trades will be responsible for the pipes from the extract fan.

D. Fresh Pipes Interface

100mm outside bathroom or 100mm below down stair floor.

- cold water
- waste pipe
- HAVC pipe
- hot water
- sewage pipe
- ➔ work interface
- ⚠ bathroom interface is excluded plumbing & decoration work.

■ Direct Drainage

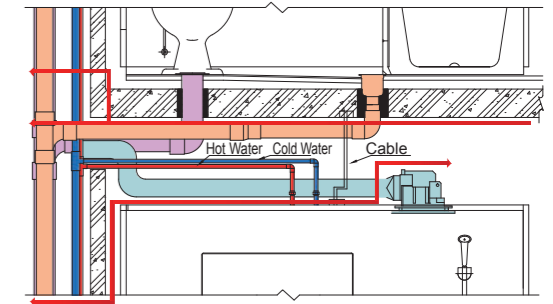

■ Indirect Drainage

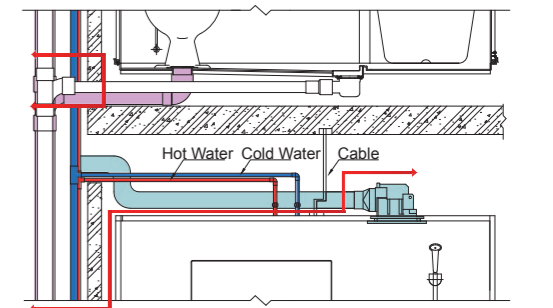

NOTE

■ INSTALL ENVIRONMENT

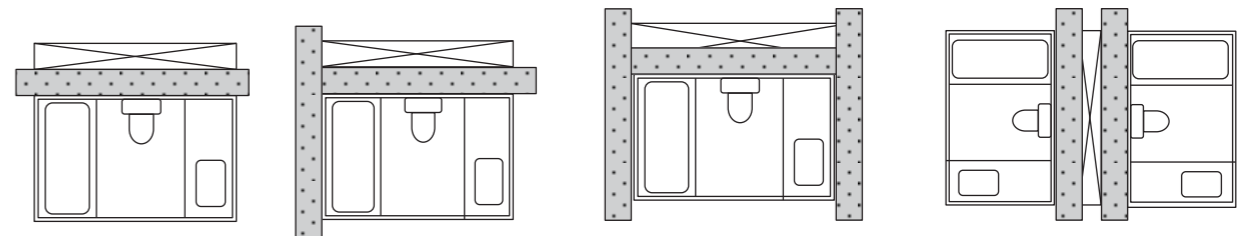

Bathroom pod could be installed after the building work as above.

■ BARRIER FREE

For barrier free design, the recess slab requires over 70mm in depth.